titan furniture

The Directory
2022

CONTACT:

ALPHA 
OFFICE SOLUTIONS LTD

Contact us today for pricing:

0121 707 4967
sales@alphaoffice.co.uk

www.alphaoffice.co.uk

LOGIN REQUIRED FOR DISCOUNTED PRICING

Office A11, Bizspace Business Park, Birmingham, B11 2AL
VAT REG 922 2384 42 COMPANY REG: 6430214



HELLO, WE ARE TITAN.

We're a worldwide designer, manufacturer and distributor of the strongest and finest range of classroom furniture and are part of the tc group.

We recognise that in an educational environment, comfort is key to help improve concentration and a student's ability to learn. We endeavour to ensure that our furniture is durable, supportive and appropriate for all learning spaces.

That's why we were the first UK manufacturer and distributor to meet British ergonomic standards set out by the technical committee for Europe.

One of the biggest battles in education is making sure it is tailored to an individual's specific needs. One way of tackling this is by making the learning environment as flexible as possible.

This catalogue includes an extensive range of furniture for all key stages spanning from Foundation all the way up to post 16 years. The age range and variation in product type allow you to create a flexible and collaborative learning environment.



OUR VALUES

Do what is right, always do it together, be extraordinary, aim high and keep it real.

Our way of thinking always starts with 'people first'. Being real and bringing our authentic selves to work each day helps build trust and accountability among our teammates, which creates a positive environment to do our best work. We collaborate with our co-workers and clients - valuing each other's ideas and believing that teamwork will produce the best results.

And every one of us cares. About everything really, be it the materials we use, the environments we create or simply about always doing the right thing. Each of us brings a different talent to the table, and together we make the finest education furniture.

CONTENTS

03	We are Titan
06	Environment & Recycling
07	Titan's Circular Economy
08	Standards
09	Certification & Guarantees
10	Our Services
11	Delivery
12	Nursery / Primary
14-15	Infant
16-17	Floor Cushion & T-Bag
18	Primary / Secondary
20-21	One Piece
22-23	4-Leg
24-25	Skid
26-27	Swivel Chairs
28-29	Swivel Stools
30-31	Move
32-33	Stools
34-35	High Chair
36	Secondary / Further
38-39	Arc Four-Leg, Four-Leg with Brace, Skid & Reverse Cantilver
40-41	Arc High Stool, Mobile Four-Leg & Dynamic 3D Tilt
42-43	Arc Community & Swivel
44-45	Folding Chairs
46-47	Titan Accessories

48	Tables
50-51	Tables
52-53	Exam Desks
54-55	Multipurpose Tables
56-57	Folding Tables
58-59	Tilting Tables
60-61	Cove Desk
62	Storage
64-65	Small Trays
66-67	Medium Trays
68-69	Large Trays
70-71	Steel Storage
72-73	Wooden Storage
74	Breakout
76-77	Chairs - Soft Seating
78-79	Phonics
80-81	Picnic
82	Teacher Furniture
84-85	Teacher Furniture
86	Screens & Whiteboards
88-89	Mobile Screens
90	Screen Accessories
91	Tray Swatches

ENVIRONMENT & RECYCLING

Here at Titan, we recognise that respecting the environment has never been so important, and therefore we want to make sure we do our part in having the smallest negative impact possible.

So much so, waste from our production of Titan chairs or chairs that do not meet our quality control standards are either recycled and used to make general household objects such as milk crates, supermarket bread baskets and wheelie bins. The metal and plastic components can be refurbished and reused to ensure we continuously feedback into the production of new Titan Chairs and reduce our impact on the environment.

Concern for the environment and the connection humans have with it is an integral and fundamental part of

Titan's corporate business strategy and this reflects in our products. We have launched our first ever sustainable, contemporary, wooden classroom chair that is available in the form of a stacking, canteen and conference chair.

Crafted from layers of premium beech veneer, it is FSC certified, which means the product is environmentally friendly and protects and maintains high conservation value forests.

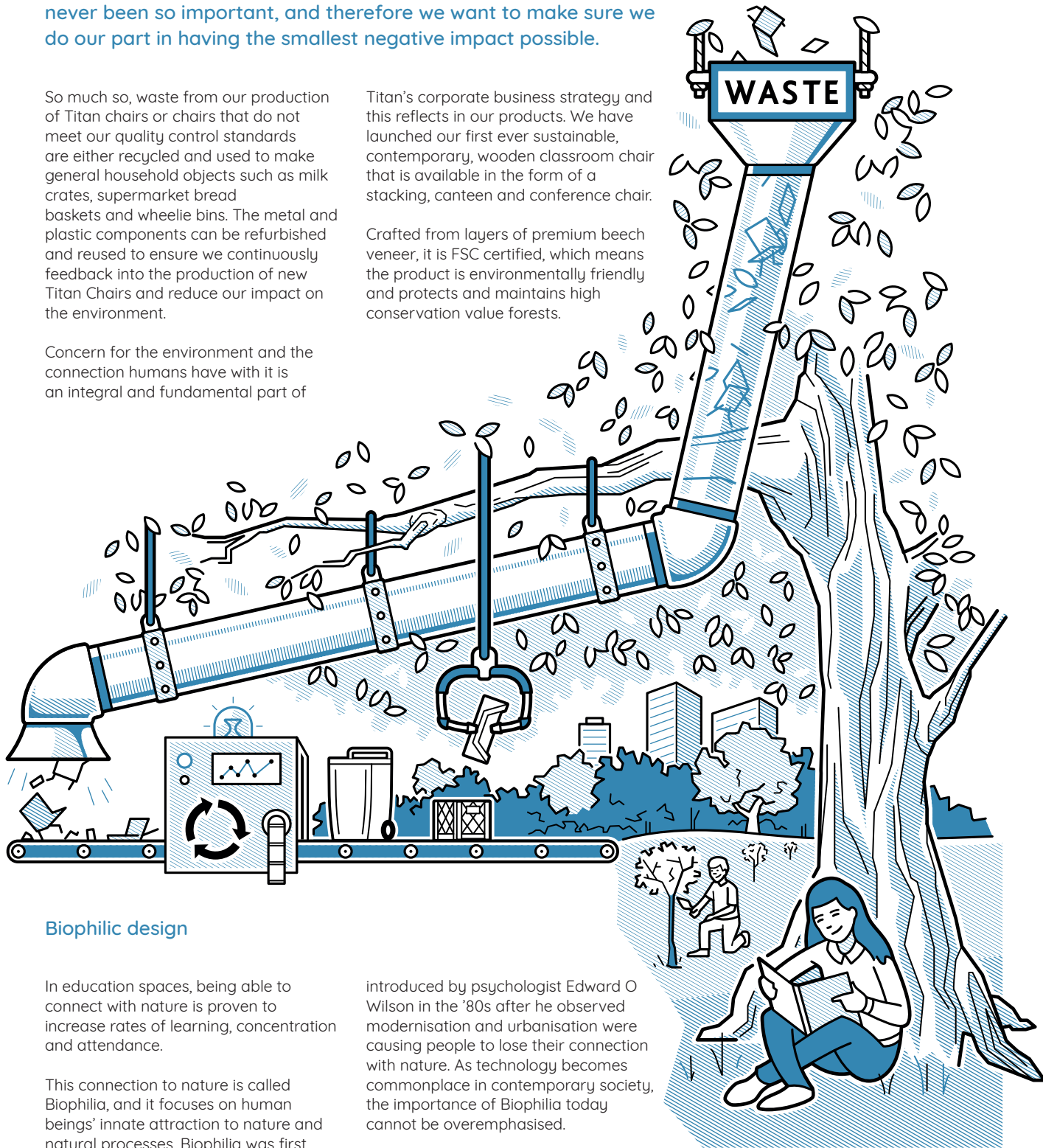

Biophilic design

In education spaces, being able to connect with nature is proven to increase rates of learning, concentration and attendance.

This connection to nature is called Biophilia, and it focuses on human beings' innate attraction to nature and natural processes. Biophilia was first

introduced by psychologist Edward O Wilson in the '80s after he observed modernisation and urbanisation were causing people to lose their connection with nature. As technology becomes commonplace in contemporary society, the importance of Biophilia today cannot be overemphasised.

TITAN'S CIRCULAR ECONOMY

1. We sustainably source all our materials at Titan. Any leftover plastic waste that cannot be mechanically recycled is sent to Plastic Energy. Plastic Energy chemically recycle plastic waste and uses the energy produced to operate their recycling plants for years to come.
2. By using predominately plastic and steel all Titan branded furniture is fully recyclable
3. The design of Titan chairs is carefully thought out for both their use and their reuse. The continuous design ensures there are no pinch points or sharp edges, great for children in educational settings, and also ensures no unnecessary materials are used, such as binding glue. The legs on plastic chairs are gas injected which allows the legs to be hollow and minimise the amount of plastic use.
4. During the production of our Titan chairs, we minimise the amount of waste. Still, the small amount that does get wasted during production is made into new black chairs, milk crates or wheelie bins by mechanically recycling plastic.
5. We offer up to 20 year guarantees on our Titan chairs, and also replace components wherever possible.
6. If for some reason up to 20 years is just too long for you, we can collect your old chairs and feed them back into making something new!

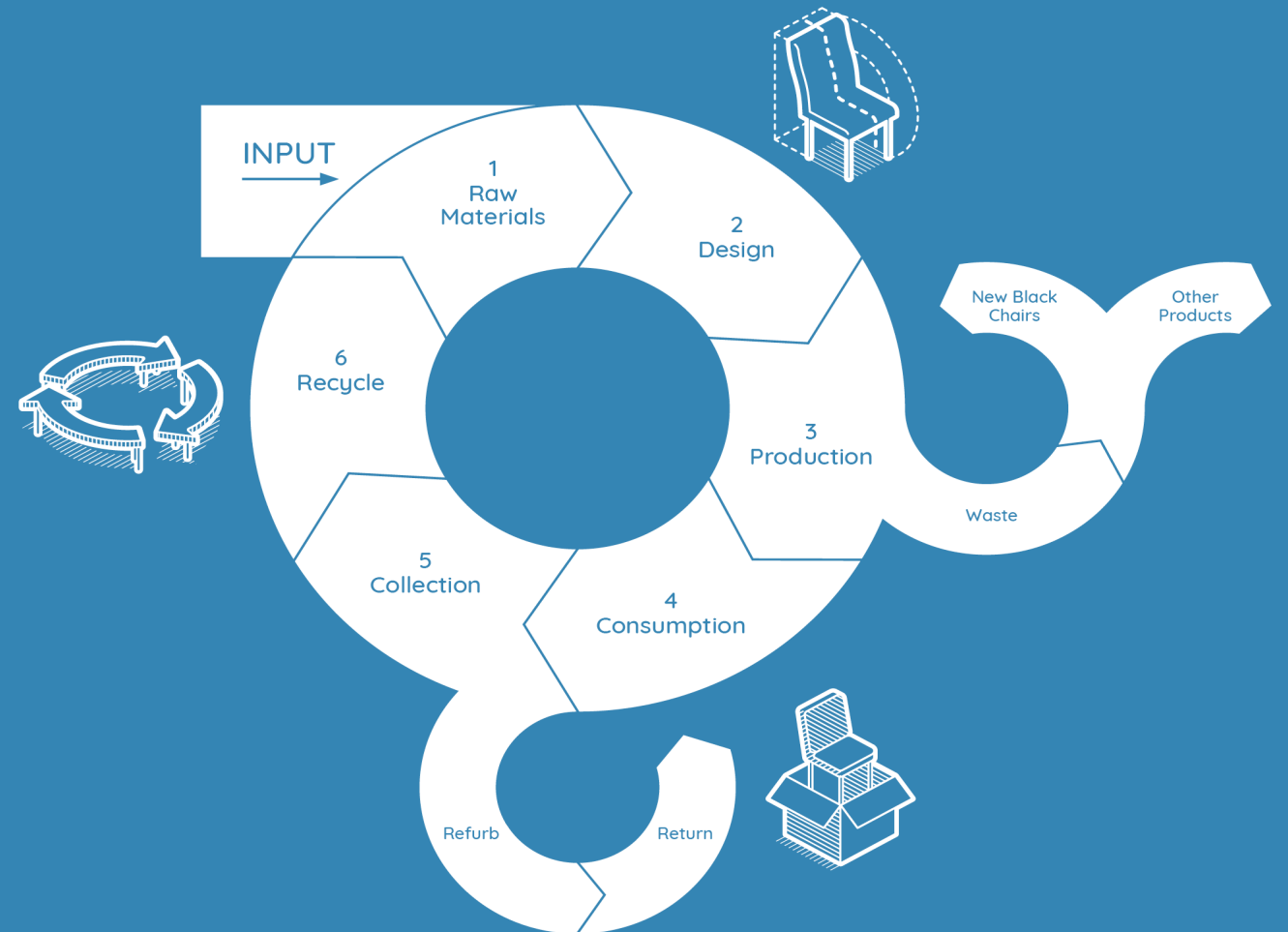

STANDARDS

We make all our products with comfort and durability in mind. We know that school furniture needs to support children, improve their posture, and endure the demanding environments of classrooms. Our furniture is constructed to be ultra-strong so that it can withstand high impacts while still being easy to maintain.



Designed for Classrooms

Our furniture is designed to suit various classroom environments. Our seating comes in a range of sizes and colours and is strong and durable yet light weight for easy moveability to create stimulating classrooms.

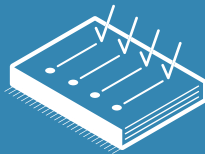

Independently Tested

All of our products are independently tested to conform to the latest British Standards for ergonomics, strength and stability.

- Ergonomics for schools BS EN 1729:1
- Strength and stability for schools BS EN 1729:2



Ergonomics

Our seating ranges have ergonomically designed back angles to promote a positive S shaped spine, which reduces the risk of lower back pain. The chairs are produced in a range of sizes to best accommodate children of all ages.



Safety

Designed for the needs of the classroom, our products are anti-tamper and low maintenance. There are no sharp edges on any of our products and most of our chairs have no pinch points and many also have anti-tilt legs.



ISO 9001 - Quality Control

We comply with ISO 9001 quality control standards which ensures our products and services are of the highest possible quality. This provides you with complete peace of mind during the ordering process and product life-cycle.

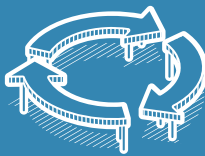

Recyclable

We are committed to trying to provide environmentally friendly products. All of our metal and plastic can be recycled to help you meet your recycling targets.



Strength

Our furniture range is constructed to be ultra-strong and withstand the toughest classroom environments. Titan products are built using high durable polypropylene and super strong steel.



Longevity

We are very confident in the quality of our products. That is why our entire range comes with extensive guarantees which protect you against the unlikely event of product failure.

CERTIFICATION & GUARANTEES

We only supply premium furniture products that are industry certified and have gone through extensive quality controls. As a result, we confidently offer long guarantees with our range.

All our seating products carry a 5-year guarantee as standard, unless indicated otherwise. Our standard guarantee applies when the product has been maintained and used for the purpose intended, under normal conditions. Replacements necessitated by accidents, improper care or use, negligence or a natural breakdown of colours and materials over an extended period of time and use are not covered.

Our Titan One Piece chairs come with an impressive 20-year guarantee. They are made from ultra-strong polypropylene and are well documented in terms of their longevity, comfort and safety in the school environment. They have no screws making them tamper proof and have no sharp edges to prevent damage or injury.

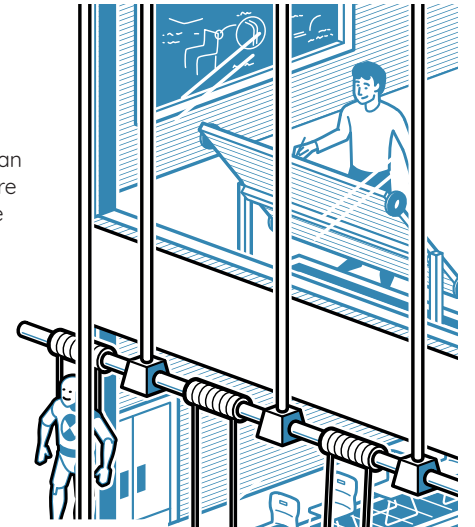

EN 1729 Size Colour Coding

We conform to EN 1729 standards of colour coding different size seating for children. That is why several of our seating ranges such as the Skid and 4-Leg have different colour feet depending on the size of the chair.

SIZE	COLOUR	SEAT HEIGHT	TABLE HEIGHT
1	Orange	260mm	460mm
2	Purple	310mm	530mm
3	Yellow	350mm	590mm
4	Red	380mm	640mm
5	Green	430mm	710mm
6	Blue	460mm	760mm

FSC approved

Titan's new wooden chair is also FSC tree tick approved which ensures the process of making this chair is environmentally appropriate.

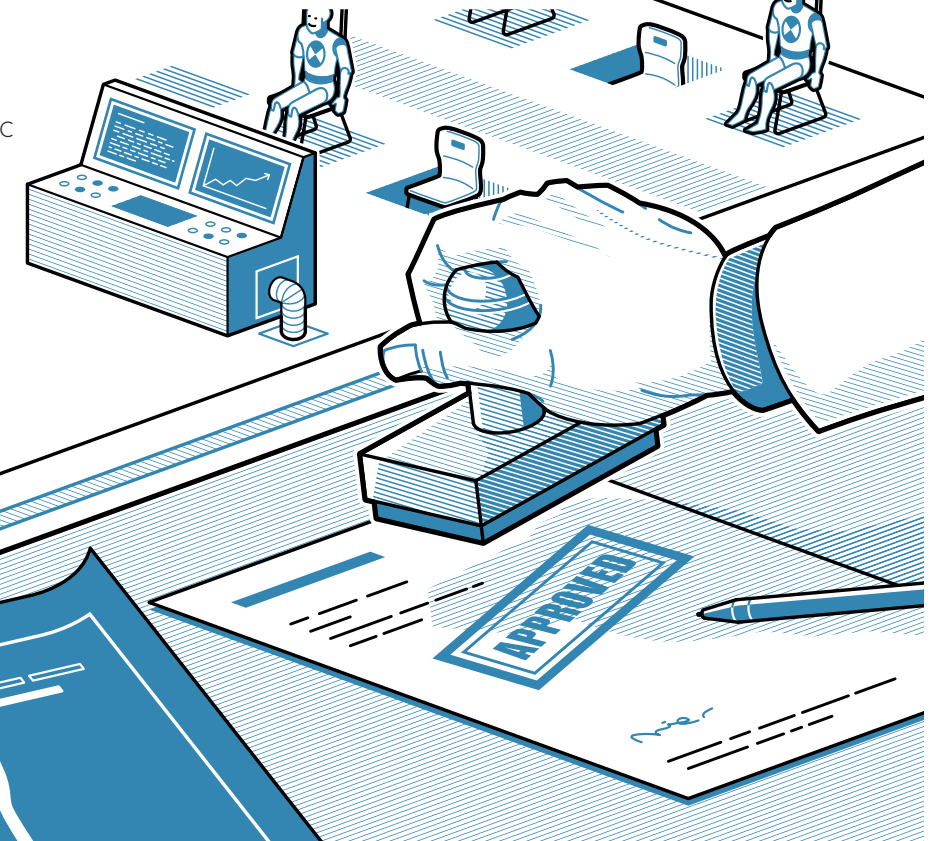

OUR SERVICES

Dedicated to making your ordering experience as smooth as possible by tailoring your order especially for you; you can complete your Titan order with the help of our other services below:

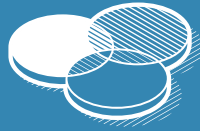

Unlimited Colours

You can order your Titan chairs in almost any colour you desire, the possibilities are endless! Simply send us a sample of the colour you wish your chairs to match and we'll take care of the rest.

- A minimum order of 300 chairs will be manufactured at no extra cost.
- Orders for fewer than 300 chairs may be subject to a surcharge.
- Please allow up to 12 weeks for delivery of special colours.

The Titan One Piece sizes T5 and T6 are moulded in the UK allowing us to deliver special colours and larger project quantities in these sizes much quicker. Up to 1800 chairs can be delivered on just one of our super size curtain sided delivery trucks!



Upholstery

All Titan chairs can be fitted with an upholstered seat pad for added user comfort. These are available as standard in any colour in the Bradbury Pyra or Advantage fabric range. Both fabric ranges and foams are fire retardant. Unlimited fabrics and colours are available on request.

DELIVERY

We have a few delivery services available, all tailored to you and your specific requirements. If you need any more information about any of the services outlined below, please contact our sales team and they will be delighted to assist you.



Delivery & Installation

We offer a quality Delivery and Installation service which takes the stress out of setting up your new furniture.

An installation team will deliver and install to an onsite location of your choice. Upon completion of any installation all unwanted packaging will be removed, and where possible, recycled, leaving the site ready for immediate use. All of our delivery and installation staff are fully insured and health and safety certified.

The process is as follows:

- You will be able to book a delivery slot within or outside opening times.
- We will ascertain any issues that may prevent delivery (i.e. parking restrictions).
- All ordered products will be checked before leaving our warehouse.
- You will receive a call 1 hour prior to delivery to prepare you for our team's arrival.
- Delivery will be carried out by our dedicated Titan drivers using our own vehicles.
- The goods will be unpacked and inspected to ensure nothing is damaged.

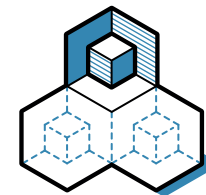

Room of Choice

If you need some additional assistance, but not full delivery and installation, our Room of Choice option is the service for you.

We offer a two person delivery, to the room the products are being used. We take out all the heavy lifting and transporting of goods, leaving everything exactly how you want it.

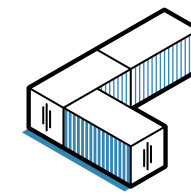

Containerised

All Titan furniture products can be supplied in 40 foot cubed and 20 foot cubed container quantities for shipping to any address worldwide. Choosing direct container delivery will reduce the carbon footprint and cost of your order.

Please note:
Some items may come in component form for container deliveries.

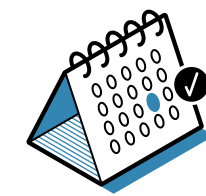

Nominated Day

We endeavor to make life just that little bit easier for all our customers. Our Nominated Day delivery service is tailored to fit around you. You choose the day and time slot; we'll do the rest.

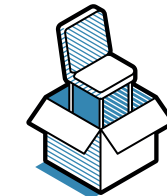

Assembled Chair

We understand that sometimes assembling chairs can be time-consuming. Here at Titan we take that problem away by offering an Assembled Chair service. Your chair will arrive built, fully functioning, boxed, and ready to use.

NURSERY / PRIMARY

// 01

Here you'll find furniture designed for children up to 6 years old. At this stage, children learn through games and play. Specific areas of learning include communication and language, physical development, and expressive arts and design. Creating a flexible and engaging educational environment at this key stage is crucial in a child's early development.





INFANT

The Titan One Piece, and Titan 4-Leg infant chairs have been specifically designed for children aged 3 to 6 years in classroom environments. These infant chairs are ultra-strong, tamper-proof, have anti-tilt legs, an optional antibacterial additive and the continuous one-piece design ensures there are no pinch points or sharp edges to cause injuries.

STACKABLE	ULTRA STRONG	20 ^{YR} GUARANTEE	8 ^H HOURS USAGE
CLASSROOM SAFE	LUMBAR SUPPORT	ANTI TILT	



ONE PIECE SIZE 1 // AGES 3 - 4

	Overall Dimensions	Seat Dimensions
T1	D320 W360 H513	D279 W275 H260
T1AN	D320 W360 H513	D279 W275 H260

Weight capacity: 97kg
Storage: Stacks 15



ONE PIECE SIZE 2 // AGES 4 - 6

	Overall Dimensions	Seat Dimensions
T2	D343 W363 H563	D279 W275 H310
T2AN	D343 W363 H563	D279 W275 H310

Weight capacity: 97kg
Storage: Stacks 15



STACKABLE	ULTRA STRONG	5 ^{YR} GUARANTEE	8 ^H HOURS USAGE
CLASSROOM SAFE	LUMBAR SUPPORT	ANTI TILT	



4-LEG SIZE 2 // AGES 4 - 6

	Overall Dimensions	Seat Dimensions
T12	D375 W420 H665	D296 W387 H350

Weight capacity: 95kg





T-BAGS

The T-Bag collection is a perfect solution for a flexible educational environment. They're lightweight and easy to move around, which makes these products ideal for classrooms and school libraries.

CLASSROOM SAFE	2 ^{YR} GUARANTEE	8 ^H HOURS USAGE	MADE TO ORDER 15 DAYS
----------------	---------------------------	----------------------------	--------------------------



GOLIATH

Overall Dimensions	
T-BAG-GOLIATH	D2000 W1320 H200

- Wipe clean cover
- No liner
- 15 cuft polybead filling

GN	RB	P	R	O
Y	L	SB	BK	HP



MEDIUM

Overall Dimensions	
T-BAG-MEDIUM	D750 W750 H650

- Easily removed wipe clean or dry clean cover
- 3.5 cuft polybead filling

GN	RB	P	R	O
Y	L	SB	BK	HP



FLOOR

Overall Dimensions	
T-BAG-FLOOR	W680 H680

- Easily removed machine washable cover
- 1.5 cuft polybead filling

GN	RB	P	R	O
Y	L	SB	BK	HP

PRIMARY / SECONDARY

// 02

Here you'll find furniture designed for children from 4 to 14+ years old. During these key stage's children will undergo important tests such as SAT's and GCSE's. Specific areas of learning include compulsory national curriculum subjects plus religious education and social and health education. Creating a stimulating and creative educational environment at this key stage is crucial in a child's later development.



ONE PIECE LINKING CLIP



T7 for One Piece size 5 & 6

ONE PIECE

The Titan One Piece infant chair is for children aged 6 to 14+ years, in the harshest classroom environments. It is ultra-strong, tamper-proof, has anti-tilt legs and its continuous one-piece design ensures there are no pinch points or sharp edges to cause injuries.

STACKABLE	ULTRA STRONG	20 ^{YR} GUARANTEE	8 ^H HOURS USAGE
ANTI-BACTERIAL AVAILABLE ON REQUEST	CLASSROOM SAFE	LUMBAR SUPPORT	ANTI TILT



SIZE 3 // AGES 6 - 8

	Overall Dimensions	Seat Dimensions
T3	D384 W435 H600	D331 W340 H350

Weight capacity: 107kg
Stack: 15



SIZE 4 // AGES 8 - 11

	Overall Dimensions	Seat Dimensions
T4	D408 W435 H690	D331 W340 H380

Weight capacity: 107kg
Stack: 15



SIZE 5 // AGES 11 - 14

	Overall Dimensions	Seat Dimensions
T5	D486 W480 H799	D414 W370 H430

Weight capacity: 115kg
Stack: 15



SIZE 6 // AGES 14+

	Overall Dimensions	Seat Dimensions
T6	D510 W482 H829	D414 W370 H460

Weight capacity: 158kg
Stack: 15





4-LEG

The Titan 4-Leg chair is a super sturdy yet stylish classroom chair for children aged 6 to 14+ years. It can withstand the heavy-duty day to day use of an educational environment while retaining a formal look. Moulded from one piece of impact resistant polypropylene and bolted to a super strong tubular steel frame, this is one of the more durable Titan chairs. It also comes with tamper proof fixings and anti-tilt rear legs to provide extra safety for the user.

STACKABLE	ULTRA STRONG	5 ^{YR} GUARANTEE	8 ^H HOURS USAGE
CLASSROOM SAFE	LUMBAR SUPPORT	ANTI TILT	



SIZE 3 // AGES 6 - 8

	Overall Dimensions	Seat Dimensions
T13	D375 W420 H665	D296 W387 H350

Weight capacity: 95kg



SIZE 4 // AGES 8 - 11

	Overall Dimensions	Seat Dimensions
T14	D410 W430 H695	D296 W387 H385

Weight capacity: 95kg



SIZE 5 // AGES 11 - 14

	Overall Dimensions	Seat Dimensions
T15	D475 W500 H785	D406 W423 H420

Weight capacity: 140kg



SIZE 6 // AGES 14+

	Overall Dimensions	Seat Dimensions
T16	D475 W500 H825	D363 W423 H460

Weight capacity: 140kg





SKID

The Titan Skid chair ensures ultimate classroom safety. It is for children aged between 6 to 14+ years. The seat shell is moulded from one piece of impact resistant polypropylene and bolted to a tubular steel base which has joined legs for more strength and stability. The combination of anti-tilt legs and new redesigned foot means the chair won't rock, tip, or glide across the floor.

STACKABLE	ULTRA STRONG	5 ^{YR} GUARANTEE	8 ^H HOURS USAGE
CLASSROOM SAFE	LUMBAR SUPPORT	ANTI TILT	



SIZE 3 // AGES 6 - 8

	Overall Dimensions	Seat Dimensions
T23	D370 W507 H655	D296 W387 H355

Weight capacity: 95kg



SIZE 4 // AGES 8 - 11

	Overall Dimensions	Seat Dimensions
T24	D380 W507 H655	D296 W387 H385

Weight capacity: 95kg



SIZE 5 // AGES 11 - 14

	Overall Dimensions	Seat Dimensions
T25	D485 W545 H790	D363 W423 H430

Weight capacity: 140kg



SIZE 6 // AGES 14+

	Overall Dimensions	Seat Dimensions
T26	D495 W545 H820	D363 W423 H460

Weight capacity: 140kg





SWIVEL CHAIRS

The Titan Swivel range is both innovative and stylish. Available in both junior and senior sizes, the swivel range has been created specifically for children ranging from 6 years of age to 11+. The seats have been ergonomically designed for comfort while also easily allowing for the height to be adjusted to the users preferred setting. Both Titan's swivel chairs and stools come with a super strong chrome base, easy glide wheels and gas lift.

HEIGHT ADJUSTABLE	PORTABLE	5 ^{YR} GUARANTEE	8 ^H HOURS USAGE
		CLASSROOM SAFE	LUMBAR SUPPORT



JUNIOR SWIVEL CHAIR CHROME BASE // AGES 6 - 11

	Overall Dimensions	Seat Dimensions
T30	D600 W600 H765 - 820	D320 W387 H365 - 435

Base diameter: 600
Weight capacity: 97kg



SENIOR SWIVEL CHAIR CHROME BASE // AGES 11+

	Overall Dimensions	Seat Dimensions
T35	D600 W600 H845 - 930	D406 W423 H435 - 525

Base diameter: 600
Weight capacity: 107kg



JUNIOR SWIVEL CHAIR BLACK BASE // AGES 6 - 11

	Overall Dimensions	Seat Dimensions
T30BK	D600 W600 H765 - 820	D320 W387 H365 - 435

Base diameter: 600
Weight capacity: 97kg



SENIOR SWIVEL CHAIR BLACK BASE // AGES 11+

	Overall Dimensions	Seat Dimensions
T35BK	D600 W600 H845 - 930	D406 W423 H435 - 525

Base diameter: 600
Weight capacity: 107kg





SWIVEL STOOLS

The Titan Swivel range is both innovative and stylish. Available in both junior and senior sizes, the swivel range has been created specifically for children ranging from 6 years of age to 11+. The seats have been ergonomically designed for comfort while also easily allowing for the height to be adjusted to the users preferred setting.

HEIGHT ADJUSTABLE	PORTABLE	5 ^{YR} GUARANTEE	8 ^H HOURS USAGE
			CLASSROOM SAFE



JUNIOR SWIVEL STOOL CHROME BASE // AGES 6 - 11

	Overall Dimensions	Seat Dimensions
T32	D600 W600 H445 - 500	D390 W420 H405 - 475

Base diameter: 600
Weight capacity: 97kg

GN	B	P	R	O	L	CB
C	BK	GR	[Rainbow]			

SENIOR SWIVEL STOOL CHROME BASE // AGES 11+

	Overall Dimensions	Seat Dimensions
T33	D600 W600 H505 - 605	D414 W420 H415 - 515

Base diameter: 600
Weight capacity: 97kg

GN	B	P	R	O	L	CB
C	BK	GR	[Rainbow]			



JUNIOR SWIVEL STOOL BLACK BASE // AGES 6 - 11

	Overall Dimensions	Seat Dimensions
T32BK	D600 W600 H445 - 500	D390 W420 H405 - 475

Base diameter: 600
Weight capacity: 97kg

GN	B	P	R	O	L	CB
C	BK	GR	[Rainbow]			

SENIOR SWIVEL STOOL BLACK BASE // AGES 11+

	Overall Dimensions	Seat Dimensions
T33BK	D600 W600 H505 - 605	D414 W420 H415 - 515

Base diameter: 600
Weight capacity: 97kg

GN	B	P	R	O	L	CB
C	BK	GR	[Rainbow]			



MOVE

The Titan Move chairs have been designed specifically to target the need for mobility in educational settings. The chairs allow for students to move around the classroom safely creating a more dynamic learning space. Suitable for children aged 14+, the Move can be used for either individual or collaborative use within the classroom.

ANTI-TILT

ULTRA STRONG

5^{YR} GUARANTEE

8^H HOURS USAGE

CLASSROOM SAFE

LUMBAR SUPPORT

Hand hole in the backrest to help with easy lifting.

S-shaped back design helps aid posture and maintain a healthy spine

Castors allow mobility around the classroom safely and comfortably for children aged 14+ years

MOVE // AGES 14+

	Overall Dimensions	Seat Dimensions
T301	D495 W520 H830	D363 W423 H445

Back dimensions:
W403 H400
Weight capacity: 130kg





STOOLS

An ideal option for labs due to their unique frame style that protects all laboratory flooring or matting and their impact resistant polypropylene shell. The Titan Stool is stackable or can be easily placed under desks making it perfect for versatile working environments that require a mixture of standing and sitting work for children aged from 6 to 14+ years. Ergonomically designed, and the frame includes a built-in footrest to provide extra comfort.

STACKABLE	ULTRA STRONG	5 ^{YR} GUARANTEE	8 ^H HOURS USAGE
		LUMBAR SUPPORT	CLASSROOM SAFE



SIZE 3 // AGES 6 - 8

	Overall Dimensions	Seat Dimensions
T90	D485 W550 H520	D361 W365 H435

Weight capacity: 97kg



SIZE 4 // AGES 8 - 11

	Overall Dimensions	Seat Dimensions
T91	D485 W550 H650	D361 W365 H565

Weight capacity: 97kg



SIZE 5 // AGES 11 - 14

	Overall Dimensions	Seat Dimensions
T92	D485 W550 H685	D361 W365 H610

Weight capacity: 107kg



SIZE 6 // AGES 14+

	Overall Dimensions	Seat Dimensions
T93	D485 W550 H770	D361 W365 H690

Weight capacity: 107kg





HIGH CHAIR

If you're looking for the ultimate lab chair, then look no further. These seats are ergonomically designed with integral lumbar support to ensure pupils sit with perfect posture while the frame includes a built-in footrest to promote extra comfort for children from aged 6 to 14+ years.

- LUMBAR SUPPORT
- ULTRA STRONG
- 5^{YR} GUARANTEE
- 8^H HOURS USAGE
- CLASSROOM SAFE



SIZE 3 // AGES 6 - 8

	Overall Dimensions	Seat Dimensions
T60	D485 W550 H845	D363 W423 H460

Weight capacity: 95kg



SIZE 4 // AGES 8 - 11

	Overall Dimensions	Seat Dimensions
T61	D485 W555 H955	D363 W423 H570

Weight capacity: 95kg



SIZE 5 // AGES 11 - 14

	Overall Dimensions	Seat Dimensions
T62	D485 W550 H1010	D363 W423 H615

Weight capacity: 140kg



SIZE 6 // AGES 14+

	Overall Dimensions	Seat Dimensions
T63	D485 W550 H1085	D363 W423 H690

Weight capacity: 140kg



SECONDARY / FURTHER

// 03

Here you'll find furniture designed for children from 11 years old and onwards to further education. During these final key stages of a young person's life, it is important to have a creative and collaborative working environment to make learning engaging.

RE HALL

ROOMS
1-10





Arc is anti-microbial and fire retardant as standard. Designed using compound curves for strength

ARC

5 YR
COMPONENT
GUARANTEE

115 KG
WEIGHT
TOLERANCE

Arc is endlessly adaptable and designed for use within multiple environments, such as the secondary and further education sectors, café and conference facilities, and the healthcare sector. Arc's compound curves provide comfort, ergonomics, and strength. The bag base and arm tablet accessories allow the creation of a personal workspace in and around the chair. It is one of a limited number of products that has been certified to both Parts 1 & 2 of the education standard BS EN 1729, specifying strength, stability, and ergonomic requirements.



FOUR-LEG

	Seat Dimensions	Back Dimensions
TA1_5 SIZE 5	D410 W425 H430	W405 H425
TA1_6 SIZE 6	D410 W425 H460	W405 H425

FR: UL94 V-2
Material: Polypropylene



FOUR-LEG WITH BRACE

	Seat Dimensions	Back Dimensions
TA2_5 SIZE 5	D410 W425 H430	W405 H425
TA2_6 SIZE 6	D410 W425 H460	W405 H425

FR: UL94 V-2
Material: Polypropylene



SKID

	Seat Dimensions	Back Dimensions
TA3_5 SIZE 5	D410 W425 H430	W405 H425
TA3_6 SIZE 6	D410 W425 H460	W405 H425

FR: UL94 V-2
Material: Polypropylene

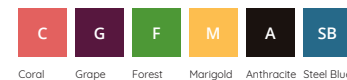

REVERSE CANTILIVER

	Seat Dimensions	Back Dimensions
TA4_5 SIZE 5	D410 W425 H430	W405 H425
TA4_6 SIZE 6	D410 W425 H460	W405 H425

FR: UL94 V-2
Material: Polypropylene





DYNAMIC 3D TILT

The Dynamic 3D Tilt chair has a unique 3D mechanism that instinctively tilts forward, back and side to side with the user's weight as they work—creating a dynamic and comfortable sitting experience.



arc-chair.com

ARC

Arc was conceived and designed in the UK. It is a new aesthetic for Titan and will define the brand for years to come. It is a robust, single shell, injection moulded chair – multipurpose and versatile with various leg sets and colour palettes from which to choose. It is 100% recyclable, fire retardant and contains an antimicrobial additive which is clinically proven to kill >99.9% of MRSA and E Coli bacteria whilst also inhibiting fungal growth.

5 YR
COMPONENT
GUARANTEE

115 KG
WEIGHT
TOLERANCE



HIGH STOOL

	Seat Dimensions	Back Dimensions
TA5_5 SIZE 5	D410 W425 H610	W405 H425
TA5_6 SIZE 6	D410 W425 H685	W405 H425

FR: UL94 V-2
Material: Polypropylene



MOBILE FOUR-LEG

	Seat Dimensions	Back Dimensions
TA6 SIZE 6	D410 W425 H460	W405 H425

FR: UL94 V-2
Material: Polypropylene



DYNAMIC 3D TILT

	Seat Dimensions	Back Dimensions
TA7	D410 W425 H445-538	W405 H425

FR: UL94 V-2
Material: Polypropylene

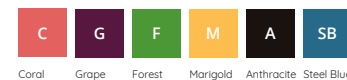

DYNAMIC 3D TILT & PERSONAL WORKSPACE

	Seat Dimensions	Back Dimensions
TA8	D410 W425 H470-535	W405 H425

FR: UL94 V-2
Material: Polypropylene





ARC

5 YR
COMPONENT
GUARANTEE

115 KG
WEIGHT
TOLERANCE

We recognise that understanding Titan's relationships with the environment in the design and manufacturing process has never been so important. We want to ensure that we do our part in having the smallest impact possible on the planet. Titan has attained ISO 14001 certification which is the international standard that specifies requirements for an effective environmental management system (EMS). It provides a framework that we as an organisation can follow, rather than simply establishing environmental performance requirements.



COMMUNITY

	Seat Dimensions	Back Dimensions
TA9	D410 W425 H470	W405 H425

FR: UL94 V-2
Material: Polypropylene

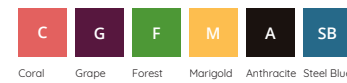

COMMUNITY & PERSONAL WORKSPACE

	Seat Dimensions	Back Dimensions
TA10	D410 W425 H470	W405 H425

FR: UL94 V-2
Material: Polypropylene

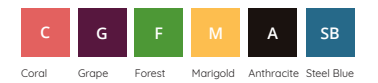

SWIVEL

	Seat Dimensions	Back Dimensions
TA11	D410 W425 H795-890	W405 H425

FR: UL94 V-2
Material: Polypropylene



SWIVEL & PERSONAL WORKSPACE

	Seat Dimensions	Back Dimensions
TA12	D410 W425 H820-890	W405 H425

FR: UL94 V-2
Material: Polypropylene

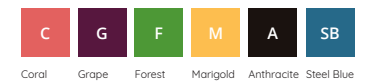



FOLDING CHAIR

The Titan Folding and Flat Folding Chair are perfect for large events, such as assemblies and gatherings. Designed with integrated linking clips, the chairs' folding ability provides for convenient and compact storage. Titan's Folding and Flat Folding Chairs not only combine double riveted construction and heavy-duty feet to provide extra strength and stability but have also been ergonomically moulded for user comfort with a breathable fan design.

2^{YR}
COMPONENT
GUARANTEE

80^{KG}
WEIGHT
TOLERANCE



FOLDING CHAIR

	Seat Dimensions	Back Dimensions
TCFAFCLK	D395 W395 H440	D440 H460



FLAT FOLDING CHAIR

	Seat Dimensions	Back Dimensions
TCFLFC	D395 W395 H440	W395 H160

FR: Low
Material: Polypropylene



TROLLEY

	Capacity	Seat Dimensions
TC40T	40	D540 W1120 H1000
TC70T	70	D1750 W790 H1100
TC140T	140	D1750 W790 H2250





TITAN ACCESSORIES

1 YR
GUARANTEE

Titan has a range of accessory products to suit your needs. All our accessories are made from durable materials and are designed to improve the functionality of our range.

The Fabric Seat Pad is available in an unlimited choice of fabrics and can help give the user better comfort. The Linking Clip can be used to connect One Piece sizes 5 and 6 chairs making them ideal for assemblies and events. The Trolleys can be used to easily transport Titan chairs and desks, which is perfect for a versatile educational environment.

CAMIRA PHEONIX OPTIONS



FABRIC SEAT PAD

	Overall Dimensions
T8	D345 W365

Upholstered in Camira Phoenix fabric
Minimum order quantity of 5



ONE PIECE LINKING CLIP

	Overall Dimensions
T7	for One Piece size 5 & 6



TROLLEY

	Overall Dimensions	Overall Dimensions
T40	D480 W650 H1158	D480 W650 H1158



TABLES

// 04

Tables are an essential part of any educational environment. The versatility and durability of tables make a huge difference in how effective teaching is. In this section you'll find a wide range of tables that are easy to move around and create tailored, collaborative, social or co-curricular educational spaces.





TABLES

5^{YR}
COMPONENT
GUARANTEE

18^{MM}
TOP
THICKNESS

A great selection of multi-purpose PU edged school tables that come in a range of heights and widths, making them suitable for both primary, secondary and further educational spaces.

Supplied KD or through our D&I service these offer a cost-effective solution to creating collaborative spaces.



590 HIGH PU EDGE TABLES SIZE 3 // AGES 6 - 8

		Overall Dimensions
T-TABLE-1259	Rectangular table	D600 W1200 H590
T-TABLE-6059	Square table	D600 W600 H590

TOP FINISHES // FRAME FINISH



640 HIGH PU EDGE TABLES SIZE 4 // AGES 8 - 11

		Overall Dimensions
T-TABLE-1259	Rectangular table	D600 W1200 H590
T-TABLE-6064	Square table	D600 W600 H640

TOP FINISHES // FRAME FINISH



710 HIGH PU EDGE TABLES SIZE 5 // AGES 11 - 15

		Overall Dimensions
T-TABLE-1271	Rectangular table	D600 W1200 H710
T-TABLE-6071	Square table	D600 W600 H710

TOP FINISHES // FRAME FINISH



760 HIGH PU EDGE TABLES SIZE 6 // AGES 14+

		Overall Dimensions
T-TABLE-1276	Rectangular table	D600 W1200 H760
T-TABLE-6076	Square table	D600 W600 H760

TOP FINISHES // FRAME FINISH





EXAM DESKS

The Titan Exam Desks have been designed to be both durable and practical. They have strong tubular steel legs for stability but can be easily folded away for compact storage. The Exam Desk Trolleys can be used to transport and store all the Titan Exams desk in quantities of 20 or 40.

- STABLE BASE
- EASY CLEAN
- ULTRA STRONG
- 2^{YR} GUARANTEE
- CLASSROOM SAFE



EXAM DESK

	Overall Dimensions
T10	D600 W600 H710

Graffiti proof wipe clean injection moulded polypropylene top with pen groove and ultra-strong 22mm diameter black EPC folding frame



MDF EXAM DESK

	Overall Dimensions
TC66EDE	15mm thick top Economy D600 W600 H720
TC66ED-PREM-720	18mm thick top Premium D600 W600 H720

18mm thick beech laminate MDF with pen groove, 22mm diameter black EPC frame with integral safety bar to assist safer folding and storage



EXAM DESK TROLLEY

	Capacity	Overall Dimensions
TCEDT-20T	20	D1225 W660 H1150

Capacity: 20 exam desks

EXAM DESK TROLLEY

	Capacity	Overall Dimensions
T10-T	40	D1267 W600 H473

Capacity: 40 exam desks



MULTIPURPOSE TABLES

Our Multipurpose Table range delivers on its promises. Choose from multiple desk configurations to tailor this furniture for your specific needs.

5^{YR}
COMPONENT
GUARANTEE

18^{MM}
TOP
THICKNESS



SEMI-CIRCULAR DESK

	Overall Dimensions
OMPT1680SEMI	D800 W1600 H730



TRAPEZOIDAL DESK

	Overall Dimensions
OMPT1680TRAP	D692 W1600 H730



RECTANGULAR DESK

	Overall Dimensions
OMPT1280REC	D800 W1200 H730
OMPT1680REC	D800 W1600 H730
OMPT1880REC	D800 W1800 H730

- A range of tables in three different shapes to enable you to make the best use of your space
- Flat pack frame construction
- Ideal for constructing meeting or boardroom tables of different shapes

STOCKED TOP FINISHES // FRAME FINISH



MADE TO ORDER TOP FINISHES





FOLDING TABLES

5 YR
COMPONENT
GUARANTEE

25 MM
TOP
THICKNESS

Our Folding Tables are a range of furniture which allows instant re-configuration. A sturdy folding frame, with 25mm thick table tops and a choice of four top finishes and two frame finishes. These tables offer versatility within an educational space with the ability to reconfigure at any point.



D-END

	Overall Dimensions
OUFT1680DEND	D800 W1600 H725



TRAPEZOIDAL

	Overall Dimensions
OUFT1680TRAP	D800 W1600 H725

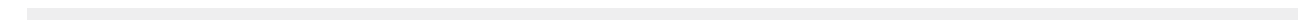

RECTANGULAR

	Overall Dimensions
OUFT1270	D700 W1200 H725
OUFT1280	D800 W1200 H725
OUFT1470	D700 W1400 H725
OUFT1670	D700 W1600 H725
OUFT1680	D800 W1600 H725

- Fold flat legs for easy storage
- Chrome and silver leg options
- Ideal for multi-functional rooms where space is a premium

STOCKED TOP FINISHES // FRAME FINISH



MADE TO ORDER TOP FINISHES

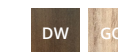



TILTING TABLES

5 YR
COMPONENT
GUARANTEE

25 MM
TOP
THICKNESS

The Tilting Tables are a range of portable tables where the tops can be released and tilted 90 degrees, allowing secure storage and flexible working environments. Either stacked or nested, these tables are ideal for rooms where space is a premium. The castors are also lockable which allows them to be temporarily locked in at any point.



D-END

	Overall Dimensions
OTT1470DEND	D700 W1400 H720
OTT1680DEND	D800 W1600 H720



TRAPEZOIDAL

	Overall Dimensions
OTT1680TRAP	D700 W1600 H720



RECTANGULAR

	Overall Dimensions
OTT1270	D700 W1200 H720
OTT1280	D800 W1200 H720
OTT1470	D700 W1400 H720
OTT1480	D800 W1400 H720
OTT1670	D700 W1600 H720
OTT1680	D800 W1600 H720

- A mobile table with a top that can be released and tilted 90 degrees for easy storage
- Available with a white or silver frame
- Can be stacked or nested
- Ideal for multi-functional rooms where space is at a premium
- Lockable castors

STOCKED TOP FINISHES // FRAME FINISH



MADE TO ORDER TOP FINISHES

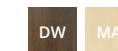



COVE DESK

Our cove desks have been designed to fit perfectly in further education settings. These desks can be arranged in various ways, tailored to the users own personal needs and requirements. Our solitary workstations are the perfect solution for loud and busy educational environments, creating a space to quietly work and study in privacy.

5^{YR}
COMPONENT
GUARANTEE

2^{YR}
UPHOLSTERY
GUARANTEE



COVE DESK

	Overall Dimensions	Desk Height
FK1200	D800 W1200 H1400	720

FR: Subject to fabric selected
Material: FSC birch plywood, FSC beech, powder coated mild steel, CMHR foam



COVE DESK

	Overall Dimensions	Desk Height
FK1400	D800 W1400 H1400	720

FR: Subject to fabric selected
Material: FSC birch plywood, FSC beech, powder coated mild steel, CMHR foam

STORAGE

// 05

The amount of space in an educational area is limited, so imaginative storage options are essential.

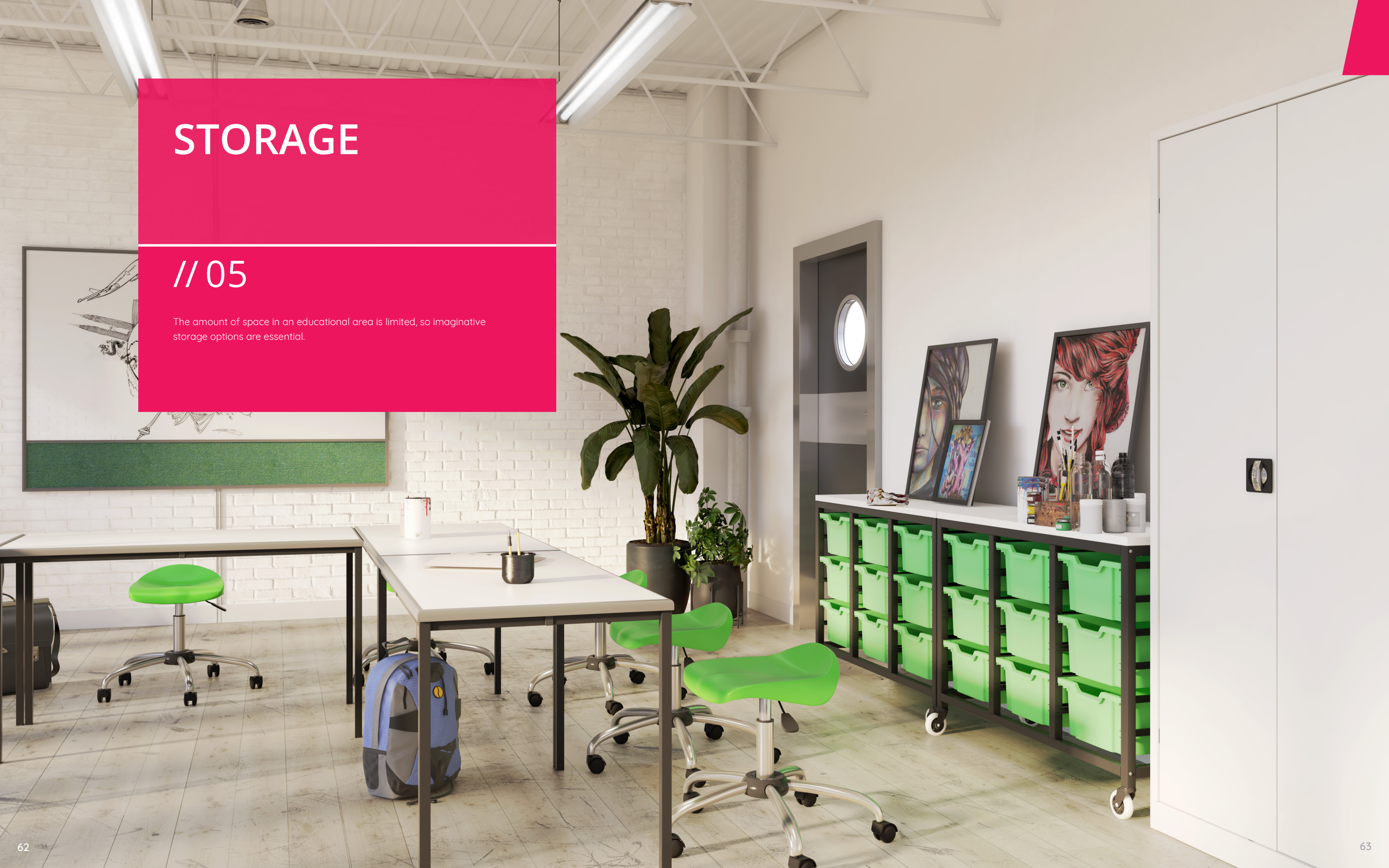



SMALL TRAYS

The Titan small trays are ideal for compact classroom settings. The Titan trays come in stacks of 6, 12, and 18, perfect for fitting in smaller spaces and storing book bags, stationery, and notebooks. These trays have been designed specifically to allow for mobility within classrooms, with easy-glide wheels.



SMALL 6 TRAYS

	Overall Dimensions
T-STOR-6D-F01BLUE	D438 W390 H795

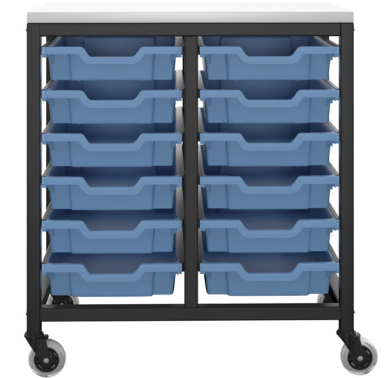

SMALL 12 TRAYS

	Overall Dimensions
T-STOR-12D-F01BLUE	D438 W748 H795

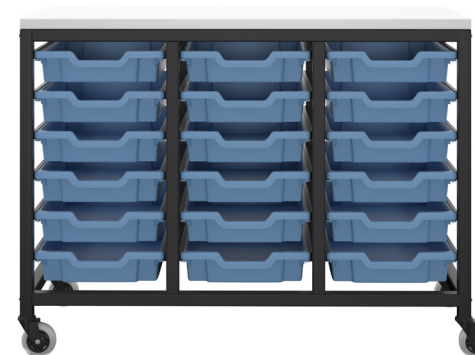

SMALL 18 TRAYS

	Overall Dimensions
T-STOR-18D-F01BLUE	D438 W1106 H795

For a full list of available tray colours, please go to page 91.



MEDIUM TRAYS

The Titan medium trays are perfect for any educational settings. The Titan trays come in stacks of 3, 6, or 9, and are ideal for storing stationery, books, and larger items that are in need of a permanent home. Created with mobility and connectivity in mind, the Titan trays provide easy glide wheelbases.



MEDIUM 3 TRAYS

	Overall Dimensions
T-STOR-3D-F02BLUE	D438 W390 H795



MEDIUM 6 TRAYS

	Overall Dimensions
T-STOR-6D-F02BLUE	D438 W748 H795



MEDIUM 9 TRAYS

	Overall Dimensions
T-STOR-9D-F02BLUE	D438 W1106 H795

For a full list of available tray colours, please go to page 91.



LARGE TRAYS

The Titan large trays are ideal for a range of educational settings. The Titan trays come in stacks of 2, 4 and 6, perfect for storing education items, books, and equipment. All Titan trays have been designed with easy glide wheelbases to provide much needed mobility and collaboration in educational spaces.



LARGE 2 TRAYS

	Overall Dimensions
T-STOR-2D-F25BLUE	D438 W390 H795



LARGE 4 TRAYS

	Overall Dimensions
T-STOR-4D-F25BLUE	D438 W748 H795

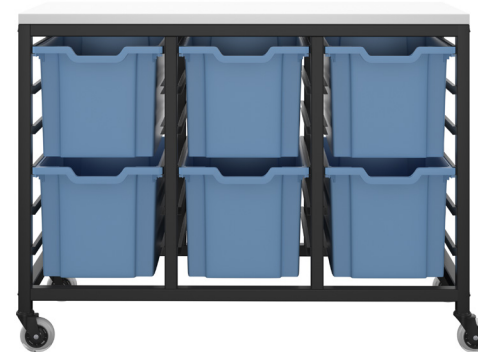

LARGE 6 TRAYS

	Overall Dimensions
T-STOR-6D-F25BLUE	D438 W1106 H795

For a full list of available tray colours, please go to page 91.



STEEL STORAGE

Manufactured from fully welded, epoxy powder coated steel; our steel storage is the perfect solution for educational spaces that need to store crucial documents. All units are complete with integral lock and two keys for added security and can be used in both a school office or university classroom.

7YR
COMPONENT
GUARANTEE

A4
SUSPENSION
FILING

FS
SUSPENSION
FILING

LOCKABLE

* Tambours only



CUPBOARDS

	Overall Dimensions
TCSDDC1000	D420 W920 H1000
TCSDDC1790	D420 W920 H1790
TCSDDC1950	D420 W920 H1950

TCS-SHELF-BK - Dual purpose cupboard shelf. Sold individually



TAMBOURS

	Overall Dimensions
TCSOT1050	D450 W1000 H1050
TCSOT1950	D450 W1000 H1950

TCSOTFF - Roll out Tambour filing frame. Sold individually

TCS-TAM-SHELF - Dual purpose Tambour shelf. Sold individually



FINISHES





WOODEN STORAGE

Manufactured from hard-wearing MFC from environmentally responsible sources; our Wooden Storage solutions are both stylish and practical.

5 YR
COMPONENT
GUARANTEE



BOOKCASES

	Shelves	Dimensions		
		W	D	H
WDS745	1	800	450	730
WDS845	1	800	450	800
WDS1245	3	800	450	1200
WDS1645	3	800	450	1600
WDS1845	4	800	450	1800
WDS2045	4	800	450	2000



CUPBOARDS

	Shelves	Dimensions		
		W	D	H
WDS745CP	1	800	450	730
WDS845CP	1	800	450	800
WDS1245CP	3	800	450	1200
WDS1645CP	3	800	450	1600
WDS1845CP	4	800	450	1800
WDS2045CP	4	800	450	2000

STOCKED FINISHES



MADE TO ORDER FINISHES

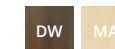

BREAKOUT

// 06

Breakout furniture is designed to provide students, co-workers and professionals alike with a space to relax and socialise while also having the capacity for agile working.

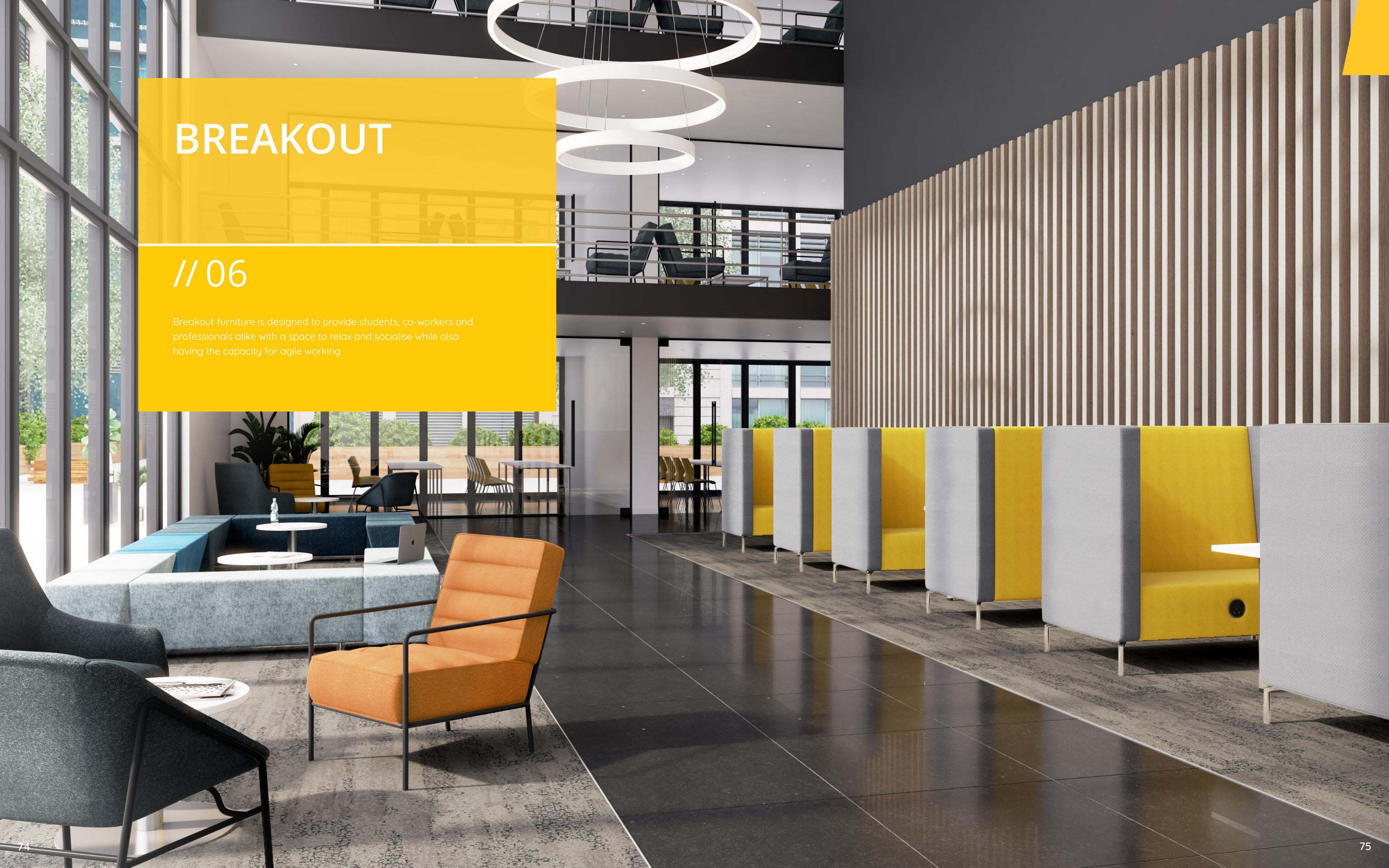



CHAIRS - SOFT SEATING

Our Soft Seating range is available in a variety of colours. Its contemporary and stylish look makes it easily adaptable for an array of different educational spaces.

5^{YR}
COMPONENT
GUARANTEE

2^{YR}
UPHOLSTERY
GUARANTEE

115^{KG}
WEIGHT
TOLERANCE

5^H
HOURS USAGE



JADE

	Seat Dimensions	Back Dimensions
OF0704	D540 W600 H390	D600 H440

FR: Med
Fabric: 100% Man-made

GR NA MU



PEARL

	Seat Dimensions	Back Dimensions
OF0705	D490 W490 H400	D570 H560

FR: Med
Fabric: 100% Man-made

GR NA MU



PHONICS

Our Phonic range includes a high back acoustic booth, with optional additional extras transforming it from a sofa into a multimedia enabled meeting space. Available through our unlimited fabric service, to ensure it compliments your existing interior.

5^{YR}
COMPONENT
GUARANTEE

2^{YR}
UPHOLSTERY
GUARANTEE

230^{KG}
WEIGHT
TOLERANCE

8^H
HOURS USAGE

MADE
TO
ORDER
42 DAYS



HIGH

		Seat Dimensions	Back Dimensions
OF3901	ARMCHAIR	D550 W550 H490	W550 H850
OF3902	2 SEATER	D550 W1100 H490	W1100 H850
OF3903	3 SEATER	D550 W1650 H490	W1650 H850



LOW

		Seat Dimensions	Back Dimensions
OF3900	ARMCHAIR	D550 W550 H450	W550 H490
OF3904	2 SEATER	D550 W1040 H450	W1040 H490
OF3905	3 SEATER	D550 W1650 H450	W1650 H490

Dimensions			
OF3903IW	INFILL PANEL	W1000 H1275	
OF0903TAB	TABLE	D910 - 400 W1400 H1275	

FR: Subject to fabric selected
Material: 100% Man-made



FR: Subject to fabric selected
Material: 100% Man-made



MADE TO ORDER TABLE FINISHES // FRAME FINISHES

BEECH	NOVA OAK	DARK WALNUT	GREY OAK	MAPLE	WHITE	//	SILVER
BE	NO	DW	GO	MA	WH		SV



PICNIC

With 2 table heights available, these benches and tables are perfect for social and collaborative working spaces.

5^{YR}
COMPONENT
GUARANTEE

25^{MM}
TOP
THICKNESS



LOW TABLE

	Dimensions
PCTL1680	W1600 D800 H751
PCTL1880	W1800 D800 H751
PCTL2000	W2000 D800 H751



HIGH TABLE

	Dimensions
PCTH1680	W1600 D800 H1111
PCTH1880	W1800 D800 H1111
PCTH2000	W2000 D800 H1111



BENCH

	Seat Dimensions
PCB1435 (FITS 1600 TABLE)	W1400 D350 H421
PCB1635 (FITS 1800 TABLE)	W1600 D350 H421
PCB1835 (FITS 2000 TABLE)	W1800 D350 H421

TOP FINISHES // FRAME FINISHES



TEACHER FURNITURE

// 07

Here you'll find furniture designed for a teacher's classroom. Ranging from your classic desk with or without a modesty panel and fixed pedestal to your two-lever operator chair; these staple items are a necessity for any classroom environment.





TEACHER FURNITURE

2 YR
COMPONENT
GUARANTEE

2 YR
UPHOLSTERY
GUARANTEE

115 KG
WEIGHT
TOLERANCE

5^H
HOURS USAGE



SINGLE LEVER

	Overall Dimensions	Seat Dimensions
CH2804	D450 W470 H460 - 590	D450 H500

FR: Med
Fabric: 100% Man-made
Mechanism: Fixed



HIGH BACK

	Overall Dimensions	Seat Dimensions
CH2800	D450 W470 H460 - 590	D450 H500

FR: Med
Fabric: 100% Man-made
Mechanism: PCB



SINGLE DESK & MODESTY PANELS

	Overall Dimensions
SINGLE DESK	
STB1274REC	D746 W1228 H725
STB1574REC	D746 W1532 H725
STB1774REC	D746 W1786 H725
SINGLE DESK + MODESTY PANELS	
STB1274RECMD	D746 W1228 H725
STB1574RECMD	D746 W1532 H725
STB1774RECMD	D746 W1786 H725



SINGLE PEDESTAL DESK

	Overall Dimensions
2 DRAWER	
STB12RECDRW2	D746 W1228 H725
STB15RECDRW2	D746 W1532 H725
STB17RECDRW2	D746 W1786 H725
3 DRAWER	
STB12RECDRW3	D746 W1228 H725
STB15RECDRW3	D746 W1532 H725
STB17RECDRW3	D746 W1786 H725



SCREENS & WHITEBOARDS

// 08

Mobile screens and whiteboard screens are a fantastic addition when flexibility is required to create different collaborative environments in a short time frame.



MOBILE SCREENS

These screens can be used for project-based tasks in educational settings such as university classrooms, serving a dual purpose of separating space between groups and enabling collaborative work.

MADE TO ORDER
20 DAYS

5 YR COMPONENT GUARANTEE



FABRIC - SINGLE TOOLRAIL

	Overall Dimensions
TKT1SKT0815UNB1	W800 H1500
TKT1SKT1015UNB1	W1000 H1500
TKT1SKT0818UNB1	W800 H1800
TKT1SKT1018UNB1	W1000 H1800

FABRIC FINISH // FRAME FINISH



FABRIC - TRIPLE TOOLRAIL

	Overall Dimensions
TKT2SKT0815UNB1	W800 H1500
TKT2SKT1015UNB1	W1000 H1500
TKT2SKT0818UNB1	W800 H1800
TKT2SKT1018UNB1	W1000 H1800

FABRIC FINISH // FRAME FINISH



WHITEBOARD - SINGLE TOOLRAIL

	Overall Dimensions
TKT3SKT0815UNB1	W800 H1500
TKT3SKT1015UNB1	W1000 H1500
TKT3SKT0818UNB1	W800 H1800
TKT3SKT1018UNB1	W1000 H1800

FABRIC FINISH // FRAME FINISH



WHITEBOARD - SINGLE TOOLRAIL

	Overall Dimensions
TKT4SKT0815UNB1	W800 H1500
TKT4SKT1015UNB1	W1000 H1500
TKT4SKT0818UNB1	W800 H1800
TKT4SKT1018UNB1	W1000 H1800

FABRIC FINISH // FRAME FINISH

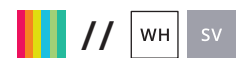

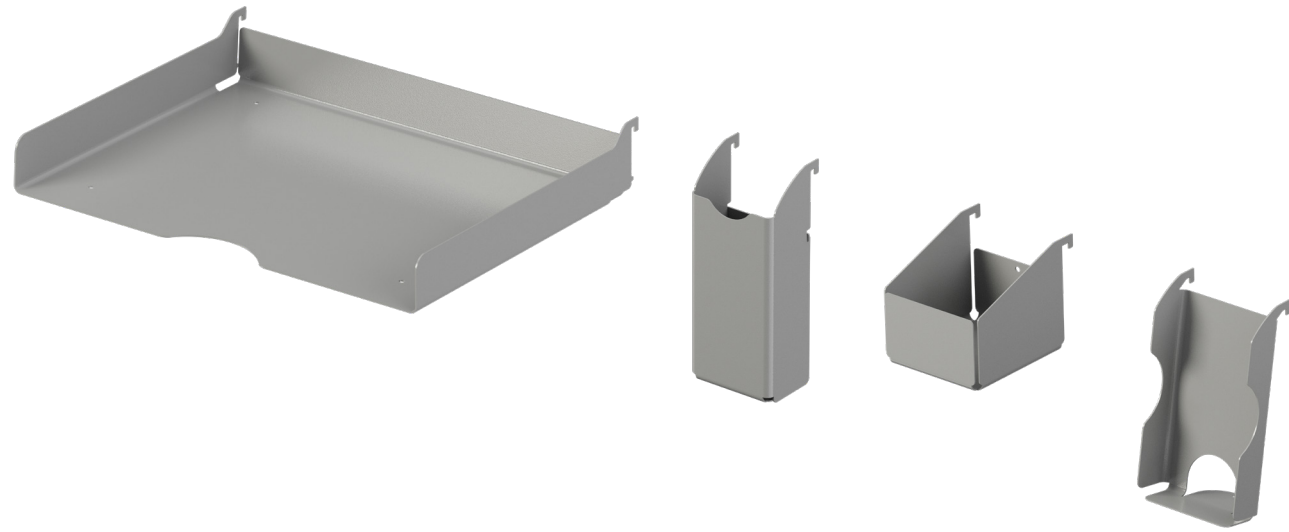

SCREEN TOOLRAIL ACCESSORIES

	Description
TKDMSTRPTA4	A4 Letter Tray
TKDMSTRPEN	Pencil Pot
TKDMSTRTP	Trinket Pot
TKDMSTRPH	Phone Holder

FINISHES



TRAY COLOUR SWATCHES

